

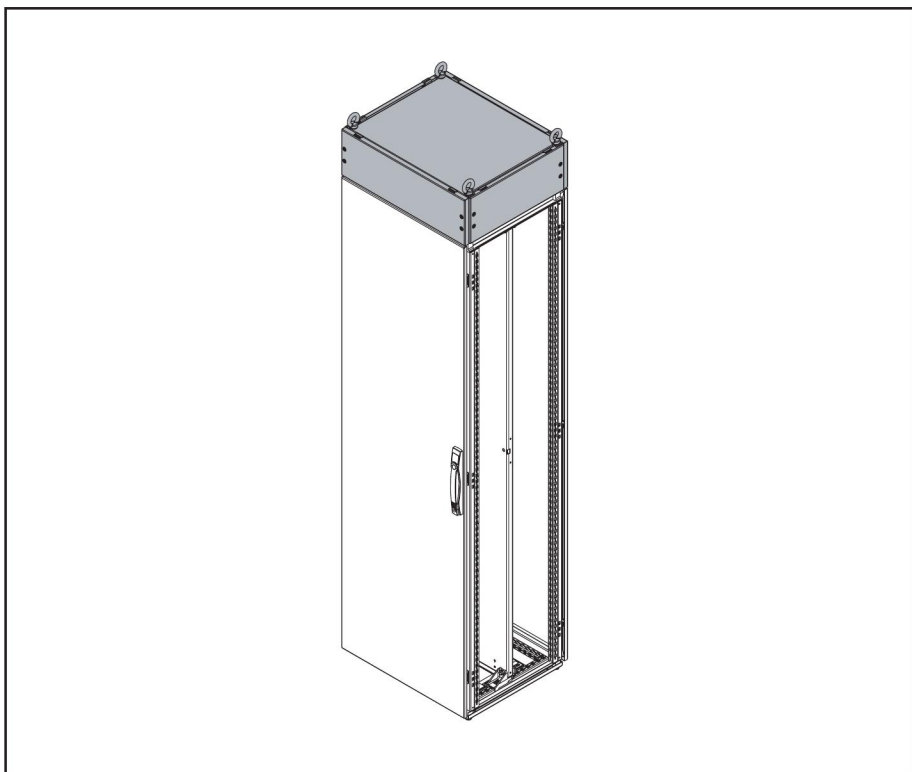

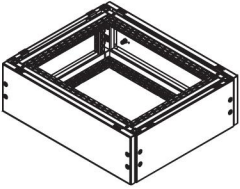





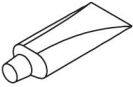

**HOFFMAN**

## ProLine G2

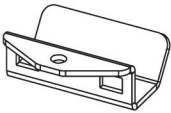

<p>1</p>  <p>(1x)</p>	<p>2</p>  <p>(3x)</p>	<p>3</p>  <p>(0x)</p>
<p>4</p>  <p>(1x)</p>	<p>5</p> <p>M8-1.25</p>  <p>(8x)</p>	<p>6</p> <p>M12</p>  <p>(0x)</p>
<p>7</p> <p>M8X1.25X25</p>  <p>(4x)</p>	<p>8</p> <p>M8X1.25X70</p>  <p>(4x)</p>	<p>9</p> <p>M12X3.175</p>  <p>(0x)</p>
<p>10</p>  <p>(8x)</p>		

